



EVOLUTION ELECTRIC VEHICLES INC
Corporate Offices: 15865 Quality Wy, Chino, CA 91708
Distribution Centers: Grand Prairie, TX; Orlando, FL
el: +86 13515056181(Non -US market countries)
sales@del-ev.com evolutionelectricvehicle.com
D5 SERIES PLUS BROCHURE V3.17 Mar. 31, 2025

     FOLLOW US

Mar. 2025

All Rights Reserved. By Evolution Electric Vehicles.



EVOLUTION
ELECTRIC VEHICLES

D5

SERIES PLUS



THE 4 PASSENGER

REVOLUTION

Evolution engages in the R&D, manufacture, and sales of electric vehicles and is the world's leading manufacturer of fleet golf carts, personal, commercial and utility vehicles.

The new model D5 is more intelligent, dynamic and self-assured than ever. With a fascinatingly cutting-edge operating system that adapts more accurately to your needs and preferences every day. Comfortable ride for 4 passengers with luxury seats featuring convenient enclosed storage for all of your adventures. Nothing appeals to the eye more than an aura of strength and athleticism. With an even more expressive golf cart design, D5's advanced electric powertrain delivers exhilarating performance. The new model has a particularly sporty charisma. Model D5 is an evolution in golf cart.



6

FACTORIES

8

PRODUCT
LINES

500,000
TOTAL SALES

“RANGER”
MODEL SHOWN

WHAT ARE THE FEATURES

01

REAR VIEW MIRRORS WITH
TURN SIGNAL LIGHT
INDICATORS

02

FOLDABLE WINDSHIELD
WITH SLIDABLE AIR VENTS

03

9 INCH MULTI-FUNCTIONAL
TOUCHSCREEN

04

MULTI-FUNCTIONAL
DASHBOARD

05

AUTOMOTIVE STYLE
STEERING WHEEL

06

ADJUSTABLE STEERING
WHEEL IN TILTING ANGLE

07

LUXURY SEATS WITH
FOLDABLE ARMRESTS

08

3-POINT SEAT BELTS FOR
EACH SEATS

09

REAR SEAT CUP HOLDERS,
USB PORTS AND STORAGE
POCKET

10

LITHIUM BATTERY

11

25A ON-BOARD FAST
CHARGER

12

GOLF BAG HOLDER DOCK

13

TOP MOUNT SOUND BAR

14

REAR STORAGE TRUNK

15

AUTOMOTIVE STYLE
REAR BUMPER

16

BRUSH GUARD FOR
OFF-ROAD MODELS

17

FRONT / REAR FENDER
FLARES

18

LED LIGHTS

19

AUTOMOTIVE E-COAT
CHASSIS

20

BACK-UP CAMERA

21

RUNNING BOARD FOR
OFF-ROAD MODELS







“MAVERICK”
MODEL SHOWN

Indicator & Lighting Stalk Switch

Horn

*Glove boxes and rear storage compartment use common keys for all locks

SWITCHES

-  STORAGE COMPARTMENT
-  POWER BUTTON
-  DIAL GEAR SELECTOR
-  HIGH/LOW SPEED MODE KNOB

MULTI-FUNCTIONAL DASHBOARD

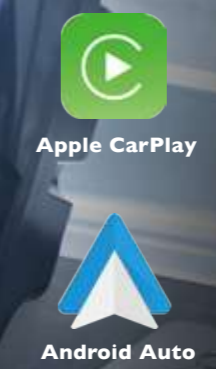

TOUCHSCREEN WITH CARPLAY COMPATIBILITY

CarPlay compatibility for a more intuitive driving experience, seamless connectivity with your favorite apps

EVOLUTION SOUND BAR

The most important advantage is the compact size and what is included in that compact size. There are sound bars with extra speakers, it can be connected wirelessly through the screen. Adjustable light modes with speaker lights beating with music tune.

FUN. FANCY. KEEP YOUR PARTY GOING



ILLUMINATED SPEAKERS

Enhance your audio experience with the Illuminated Speakers, crafted to provide exceptional sound quality and dynamic ambient lighting for a visually stunning appeal.

MODELS



RANGER 4 PLUS



RANGER 6 PLUS



MAVERICK 4 PLUS



MAVERICK 6 PLUS



RANGER & MAVERICK

FLEXIBLE CONFIGURATIONS FOR REAR COMPARTMENT

Storage trunk is configured as standard for all D5 models, golf bag holder as optional accessories for you to convert your D5 for different personal purposes.

**NEAT. FLEXIBLE. LOW COST. LIGHT WEIGHT
(FOR RANGER & MAVERICK)**



**“MAVERICK”
MODEL SHOWN**



STORAGE TRUNK



OPTIONAL GOLF BAG HOLDER



OPTIONAL ALL-WEATHER ENCLOSURE

*Glove boxes and rear storage compartment use common keys for all locks



TOP-NOTCH LUXURY SEATS

01

SEAT BACK COVER ASSEMBLY

Integrated with handrail, cup holder, storage pocket, USB charging ports ,etc
(FOR RANGER & MAVERICK)



USB CHARGING PORT

02

STANDARD SAFTY BELTS

Standard three-point safety belts for all seats, keep you safely buckled up in driving and riding.

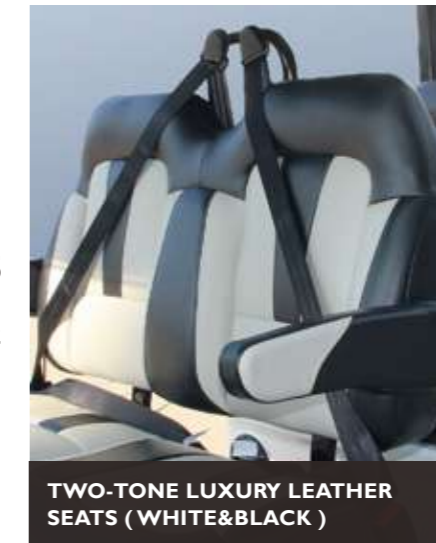

TWO-TONE LUXURY LEATHER SEATS (WHITE&BLACK)



TWO-TONE LUXURY LEATHER SEATS (BLACK&BLACK)

03 ROTATABLE ARMREST

It can rotate in 90 degree and provide an ergonomic support for your cantilever elbows.

MODELS



RANGER 2+2 PLUS



RANGER 4+2 PLUS



RANGER 6+2 PLUS

RANGER & MAVERICK



MAVERICK 2+2 PLUS



MAVERICK 4+2 PLUS

FLIP-FLOP REAR SEAT

WITH STORAGE & REAR ARMREST

(FOR RANGER 2+2 PLUS & MAVERICK 2+2 PLUS & RANGER 4+2 PLUS & MAVERICK 4+2 PLUS & RANGER 6+2 PLUS)

Rear Handrail with Footrest: Enhanced Stability and Comfort with a Built-In Footrest, Providing Extra Support and Relaxation.



REAR ARMREST WITH BUILT-IN STORAGE COMPARTMENT



UNDER SEAT CONCEALED STORAGE COMPARTMENT

OPTIONAL TOWING HITCH RECEIVER



LITHIUM
LifePO4

RADIAL TIRE

**14X7"ALUMINUM
WHEEL/ 225/55R14"
RADIAL TIRE**



SILENT TIRE WITH OFF-ROAD THREAD

**14X7"ALUMINUM
WHEEL/ 23X10-14
SILENT TIRE WITH
OFF-ROAD THREAD**



RANGER 2+2 PLUS



RANGER 4 PLUS



RANGER 6 PLUS



RANGER 4+2 PLUS



RANGER 6+2 PLUS



MAVERICK 2+2 PLUS



MAVERICK 4 PLUS



MAVERICK 6 PLUS



MAVERICK 4+2 PLUS



LED LIGHTING



**Beam At The Darkness !
Eco-Friendly. Cost-efficient.
Long Lasting. Hassle-free.**

Our personal transportation vehicles come standard with LED lights: high beams, low beam, daytime running lights, turning signals and brake lights for a brighter ride. Our lights are more powerful with less drain on your batteries, and deliver a 2-3 times wider field of vision than our competitors, so you can enjoy the ride worry-free, even after the sun goes down.



LITHIUM BATTERY

- ULTRA SAFE
- 8-YEAR WARRANTY
- MAINTENANCE FREE

The lithium-ion battery packs with integrated golf cart battery system. They are designed to replace the lead-acid batteries, which are available for drop-in replacement in golf carts easily. The benefits of lithium-ion battery include lighter weight, shorter charging time, longer life, free maintenance and less electricity bills. Our battery has an integrated management system which includes an On/Off switch and a state-of-charge(SOC) gauge.



MODEL: 48V 105Ah

MODEL: 48V 160Ah



**MOBILE & PC
LIVE MONITOR APP**



**25A ADAPTIVE
ON-BOARD CHARGER**

FEATURES



MICROPHONE

Improvement of your speech recognition, essentially eliminate factors that affect your ability to send an audio message, such as surrounding background noise, proximity to the person talking .etc

CUP HOLDERS

Never worry about messes and spills again

STORAGE COMPARTMENT

Newly designed dash has large, dual-sized storage compartment, room for more items like keys and mobile devices.

*Glove boxes and rear storage compartment use common keys for all locks



USB CHARGING PORT

USB Charging port for each seats, keep you charged on the go

GOLF BALL HOLDER

Keep you ready for golfing, Holes for four golf balls

STORAGE COMPARTMENT

Extra easy-access storage compartment in the dashboard

FEATURES



ADJUSTABLE STEERING COLUMN

Ensuring a comfortable and personalized driving experience

CHARGING SOCKET

Heavy duty charging socket, for higher current flow, better heat dissipation

HEAVY DUTY SUN TOP CANOPY

Manufactured from solid colored plastic, these tops are fitted with track enclosure rail that is built right into the top framing



ACCELERATOR BRAKE PEDAL

Automotive style stainless pedals

SLIDEABLE AIR VENTS

Enjoy the breeze skating through the vents without messing up you hair

SIDE MIRRORS WITH TURNING SIGNALS

Side mirrors equipped with turning signals for enhanced visibility and safety on the road

PPG PAINTS



FLAMENCO RED

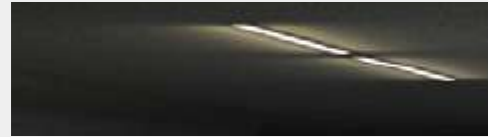

BLACK SAPPHIRE



PORTIMAO BLUE



MEDITERRANEAN BLUE



MINERAL WHITE



ARCTIC GRAY

SEAT COLORS

*PLEASE NOTE THAT DUE TO VARIATIONS AMONGST PRINTINGS, ACTUAL COLORS MAY VARY SLIGHTLY FROM WHAT APPEARS ON THIS PAGE. CHECK WITH DEALER FOR ACTUAL BRIGHTNESS/SATURATION OF A COLOR (CHECK THE PHYSICAL COLOR TEMPLATES POSSESSED BY DEALERSHIPS BEFORE YOU PLACE ORDERS). WE RESERVE THE RIGHTS TO MAKE CORRECTIONS AS WELL AS PRODUCT ALTERATIONS AND IMPROVEMENTS AT ANY TIME WITHOUT NOTICE.



MINERAL WHITE



FLAMENCO RED



ARCTIC GRAY



PORTIMAO BLUE



MEDITERRANEAN BLUE



BLACK SAPPHIRE

DIMENSIONS

D5-RANGER 4 PLUS



D5-MAVERICK 4 PLUS



DIMENSIONS

Model	D5-RANGER 4 PLUS	D5-MAVERICK 4 PLUS
Rated Passengers (person)	4	4
System Voltage (V)	48	48
Motor Power (kw)	6.3	6.3
Charging Time (H)	4-5	4-5
Dimension (mm)	2910×1418(rearview mirror)×1980	2980×1418(rearview mirror)×2105
Wheelbase (mm)	2050	2050
Wheel Tread (front/rear mm)	1020/1025	1020/1025
Maximum Speed (km/h)	20/40	20/40
Braking Distance (m)	≤3	≤3
Minimum Turning Radius (m)	4.5	4.5
Maximum Gradability (full load)	25%	25%
Curb Weight (kg)	480	502
Maximum Gross Weight (kg)	785	797
Minimum Ground Clearance (full load)	172	175
Suspension System	Front: double wishbone independent suspension Rear: leaf spring suspension	Front: double wishbone independent suspension Rear: leaf spring suspension

DIMENSIONS

D5-RANGER 6 PLUS

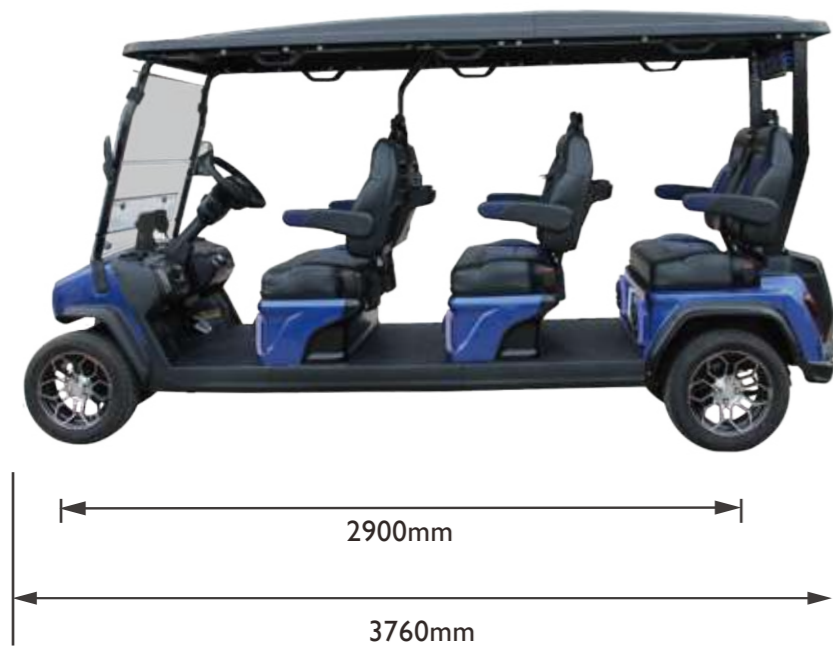

D5-MAVERICK 6 PLUS



DIMENSIONS

Model	D5-RANGER 6 PLUS	D5-MAVERICK 6 PLUS
Rated Passengers (person)	6	6
System Voltage (V)	48	48
Motor Power (kw)	6.3	6.3
Charging Time (H)	4-5	4-5
Dimension (mm)	3760×1418(rearview mirror)×2005	3830×1418(rearview mirror)×2130
Wheelbase (mm)	2900	2900
Wheel Tread (front/rear mm)	1020/1025	1020/1025
Maximum Speed (km/h)	20/40	20/40
Braking Distance (m)	≤3.5	≤3.5
Minimum Turning Radius (m)	5.8	5.88
Maximum Gradability (full load)	25%	25%
Curb Weight (kg)	610	633
Maximum Gross Weight (kg)	1059	1082
Minimum Ground Clearance (full load)	172	175
Suspension System	Front: double wishbone independent suspension Rear: leaf spring suspension	Front: double wishbone independent suspension Rear: leaf spring suspension

DIMENSIONS

D5-RANGER 2+2 PLUS



D5-MAVERICK 2+2 PLUS

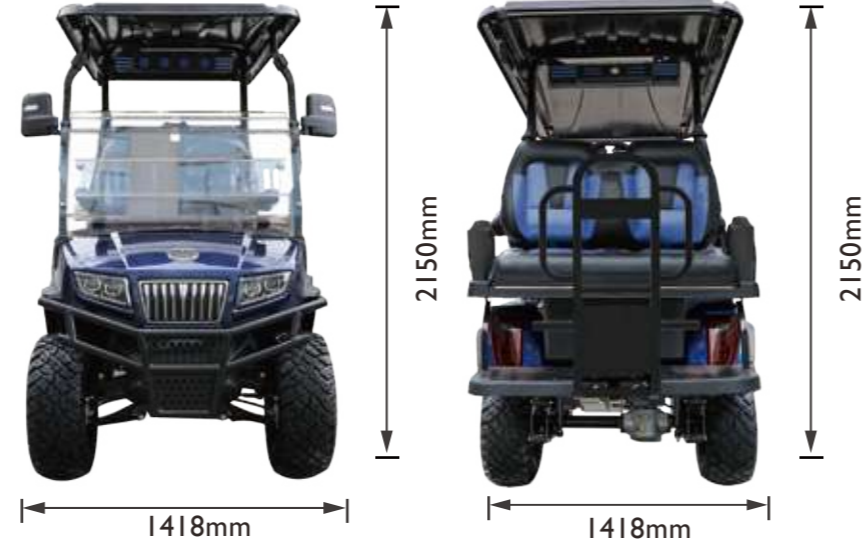

DIMENSIONS

Model	D5-RANGER 2+2 PLUS	D5-MAVERICK 2+2 PLUS
Rated Passengers (person)	4	4
System Voltage (V)	48	48
Motor Power (kw)	6.3	6.3
Charging Time (H)	4-5	4-5
Dimension (mm)	2970×1418(rearview mirror)×2045	3025×1418(rearview mirror)×2150
Wheelbase (mm)	1620	1620
Wheel Tread (front/rear mm)	1020/1025	1020/1025
Maximum Speed (km/h)	20/40	20/40
Braking Distance (m)	≤3	≤3
Minimum Turning Radius (m)	3.4	3.45
Maximum Gradability (full load)	25%	25%
Curb Weight (kg)	490	490
Maximum Gross Weight (kg)	840	840
Minimum Ground Clearance (full load)	172	175
Suspension System	Front: double wishbone independent suspension Rear: leaf spring suspension	Front: double wishbone independent suspension Rear: leaf spring suspension

DIMENSIONS

D5-RANGER 4+2 PLUS



D5-MAVERICK 4+2 PLUS



DIMENSIONS

Model	D5-RANGER 4+2 PLUS	D5-MAVERICK 4+2 PLUS
Rated Passengers (person)	6	6
System Voltage (V)	48	48
Motor Power (kw)	6.3	6.3
Charging Time (H)	4-5	4-5
Dimension (mm)	3820×1148×(rearview mirror)×2045	3875×1418(rearview mirror)×2150
Wheelbase (mm)	2470	2470
Wheel Tread (front/rear mm)	1020/1025	1020/1025
Maximum Speed (km/h)	20/40	20/40
Braking Distance (m)	≤3.3	≤3.3
Minimum Turning Radius (m)	5.2	5.25
Maximum Gradability (full load)	25%	25%
Curb Weight (kg)	558	588
Maximum Gross Weight (kg)	1008	1038
Minimum Ground Clearance (mm)	172	175
Suspension System	Front: double wishbone independent suspension Rear: leaf spring suspension	Front: double wishbone independent suspension Rear: leaf spring suspension

DIMENSIONS

D5-RANGER 6+2 PLUS

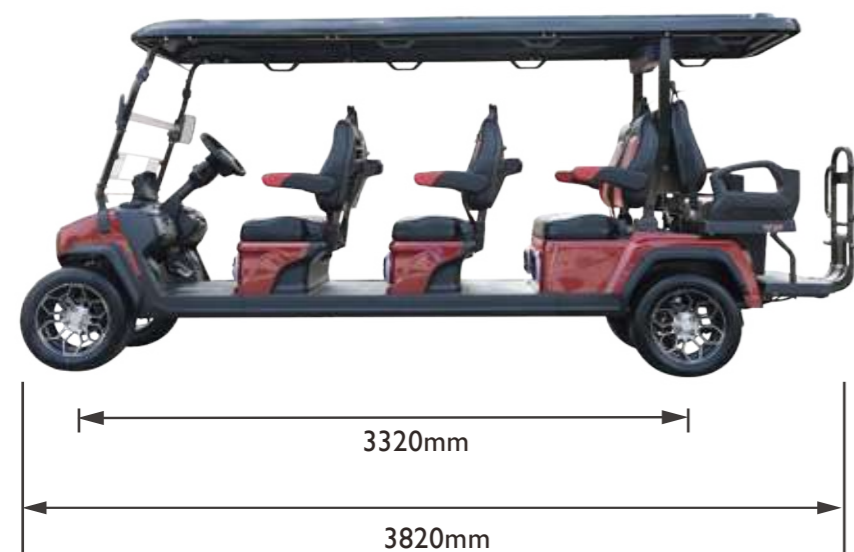

Rated Passengers (person)	8
System Voltage (V)	48
Motor Power (kw)	6.3
Charging Time (H)	4-5
Dimension (mm)	3820×1418(rearview mirror)×2895
Wheelbase (mm)	3320
Wheel Tread (front/rear mm)	1020/1025
Maximum Speed (km/h)	20/40
Braking Distance (m)	≤3.5
Minimum Turning Radius (m)	6.6
Maximum Gradability (full load)	25%
Curb Weight (kg)	634
Maximum Gross Weight (kg)	1234
Minimum Ground Clearance (mm)	172
Suspension System	Front: double wishbone independent suspension Rear: leaf spring suspension